

鉄筋コンクリート杭柵

実績

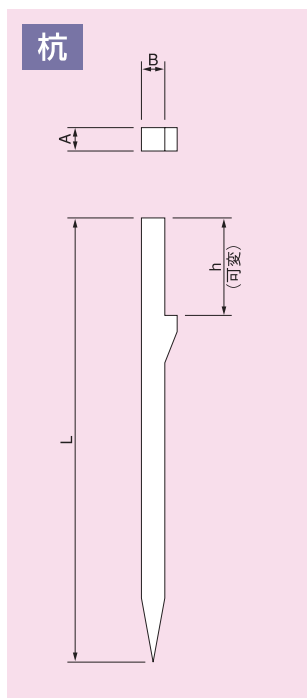

寸法図



寸法表 (杭)

呼び名	寸法 (mm)			参考重量 (kg)
	A	B	L	
150×150用	150	150	3000	164
			3500	191
			4000	220
			4500	245
			5000	274
			5500	301
200×200用	200	200	4000	380
			4500	428
			5000	476
			5500	524
			6000	572
			6500	620
			7000	668
			7500	716
			8000	764

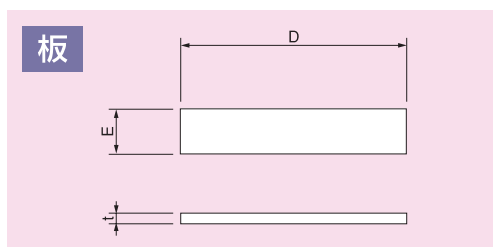

寸法表 (板)

呼び名	寸法 (mm)			参考重量 (kg)
	D	E	t	
250用	995	250	60	37
	1490			54
	995		70	43
	1490			63
300用	995	300	60	44
	1490			66
	995		70	51
	1490			75
400用	995	400	60	57
	1490	400	70	100

鉄筋コンクリート杭柵

配筋図

150×150用

標準配筋

背面土側

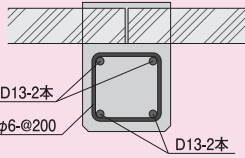

水路側

特配筋①

背面土側

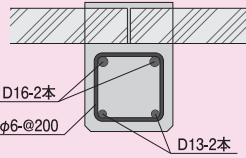

水路側

特配筋②

背面土側

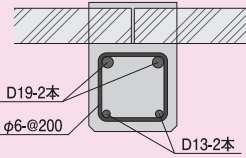

水路側

200×200用

標準配筋

背面土側

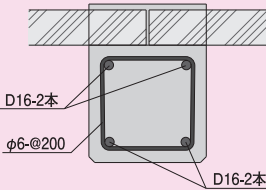

水路側

特配筋①

背面土側

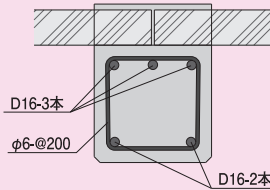

水路側

特配筋②

背面土側

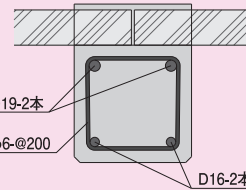

水路側

特配筋③

背面土側

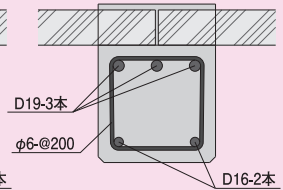

水路側

笠コン
詳細図

150×150用

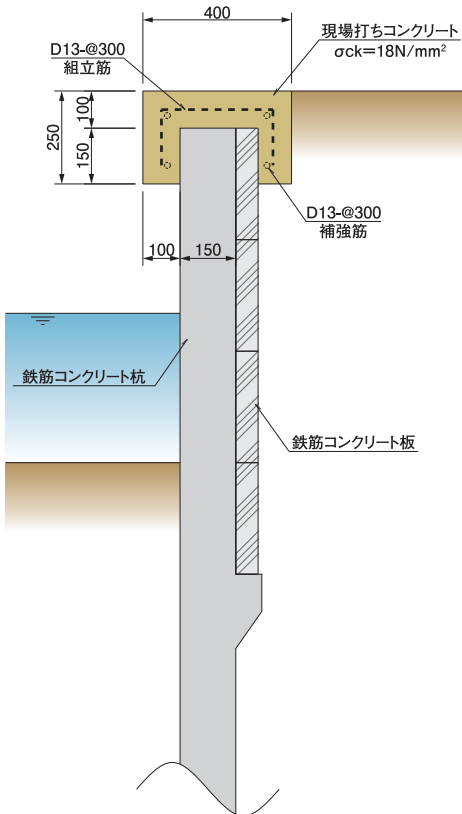

200×200用

